

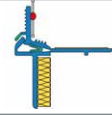

W31



APU®

PROFILES FOR COMPOUND HEAT INSULATION SYSTEMS

Window reveal bead with mesh

ROMA

With 12.5 cm mesh

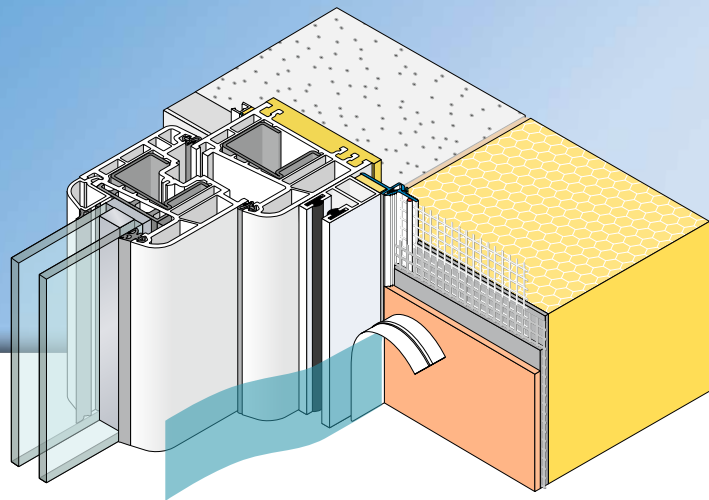

The **APU window reveal bead with mesh ROMA** is used in compound heat insulation systems as specified in the latest APU selection criteria.

Within the reveal the profile is stuck at the side onto the existing roller shutter guide rail and after completion of the plastering work forms a clean and reliable termination of the plaster.

The profile comes with a self-adhesive PE foam tape, which ensures a watertight, lasting seal. After the protective flap is pulled off, the integrated TPE

loop can absorb movements in the area around the joint. There is a fabric window reveal bead welded onto the profile. Each bar has a fabric overhang on one side of 10cm in the lengthways direction. There is a piece of self-adhesive tape on protective flap in order to secure the third-party protective film. This protects the window during the plastering work. After completion of these tasks, the protective flap is pulled off and what is created is a clean edge to the plaster.

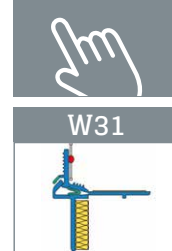

W31

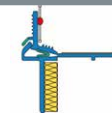

Area of application

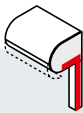
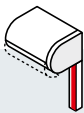
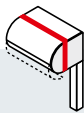
FITTING POSITION	 JUNCTION TO THE SIDE	 JUNCTION TO THE FRONT	 JUNCTION TO ROLLER SHUTTER BOX
Sub-surface	With adhesive connection – only for surfaces suitable for being stuck to ! Test of adhesion required		
Insulating material thickness	up to 300 mm		
Window size	up to 10 m ²		
W31 ROMA	■	see window reveal bead with meshes	see product documentation W81

Tested according to: ■ VDPM leaflet: Class A with adhesive connection ■ Ö-Norm B 6400-2: Class III

Fitting

- 1 Perform adhesion test.
▶ See general tips – APU test of adhesion
- 2 Cut the window reveal bead with mesh to length using suitable trimming shears with supporting surface.
- 3 Pull back the protective flap at top and bottom along the line by about 5 cm (makes removal later easier).
- 4 Pressing firmly with your thumbs, stick the profiles equally spaced and in flush alignment onto the side of the roller shutter guide rail across the entire length. To do this, pull off the covering paper of the self-adhesive PE foam tape.
- 5 Fit insulation as per manufacturer's specifications.
- 6 Prior to the plastering work, pull off the protective flap's covering paper and affix the third-party protective film for protecting the window to the adhesive surface.
- 7 Apply reinforcement base plaster, mesh and final render.
The top-level mesh must be run up to the skimming edge.
- 8 When the plastering and painting work has been finished, remove the protective film.
Fold the protective flap forward and backward along its entire length, hold by the pulled back ends and pull it off to the front.

Important information

- Any applications not clearly described in the documents may be implemented only after consultation with the plaster or ETICS manufacturer.
- When the work is being done, the surface temperature must be at least +5 degrees and must not exceed +40 degrees.
- After being set in place on the structural element, profiles with a mesh vane must be promptly embedded. Until then they must be protected from the weather, e.g. sun and wind.
- If the necessary profile length is not available, it is possible in the upper third of the structural element to create a butt joint by butting the profiles up against each other.
- The processing guidelines of the plaster manufacturer shall be complied with.